

BRONZE FIXED ORIFICE DOUBLE REGULATING VALVE

PN25 F6G25



FEATURES & SPECIFICATIONS

- Single unit Y-pattern globe valve incorporating fixed orifice plate flow measurement unit
- Fitted with a pair of measuring plugs
- High measurement accuracy of +/-5% across all opening settings
- Microset handwheel and presetting scale is readable from all directions
- Regulating and isolating functions
- Threaded to BS EN 10226-1 (ISO 7)
- Comply with BS 7350
- Applicable for hydronic balancing of heating and cooling systems



PRESSURE & TEMPERATURE RATINGS

Working Pressure	25bar
Shell Testing Pressure (x1.5)	37.5bar
Seat Testing Pressure (x1.1)	27.5bar
Working Temperature	-10°C ... 120°C
Suitable Media	Water

MATERIAL SPECIFICATIONS

Part	Material	Specification
Body	Bronze	EN 1982 CC491K
Bonnet	DZR Brass (DN15 ... DN32)	EN 12165 CW602N
	Bronze (DN40 ... DN50)	EN 1982 CC491K
Stem	DZR Brass	EN 12165 CW602N
Balancing Cone	DZR Brass	EN 12165 CW602N
Disc	DZR Brass (DN15 ... DN20)	EN 12165 CW602N
	DZR Brass+PTFE (DN25 ... DN50)	EN 12165 CW602N
Disc Retaining Ring	DZR Brass	EN 12165 CW602N
Orifice Insert	DZR Brass	EN 12165 CW602N
Measuring Plug	DZR Brass	EN 12165 CW602N
Handwheel	DZR Brass	EN 12165 CW602N
O-Ring	EPDM	

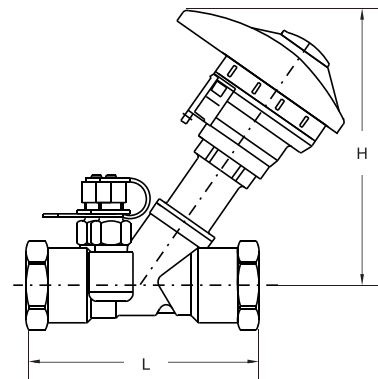

DIMENSIONS & FLOW COEFFICIENT

DN (mm)	15	20	25	32	40	50	(mm)
DN (inch)	½	¾	1	1¼	1½	2	
L	87	96	100	114	125	146	
H	113	114	135	136	151	152	
Kvs (Fully Open)	2.2	4.6	8.5	16.7	26.1	43.2	
Handwheel Turns	4	4	4	4	4	4	

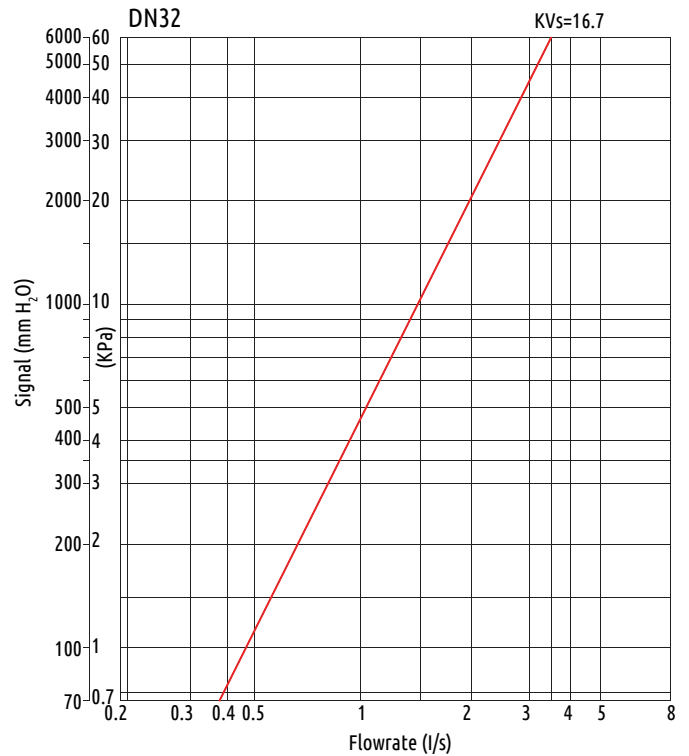
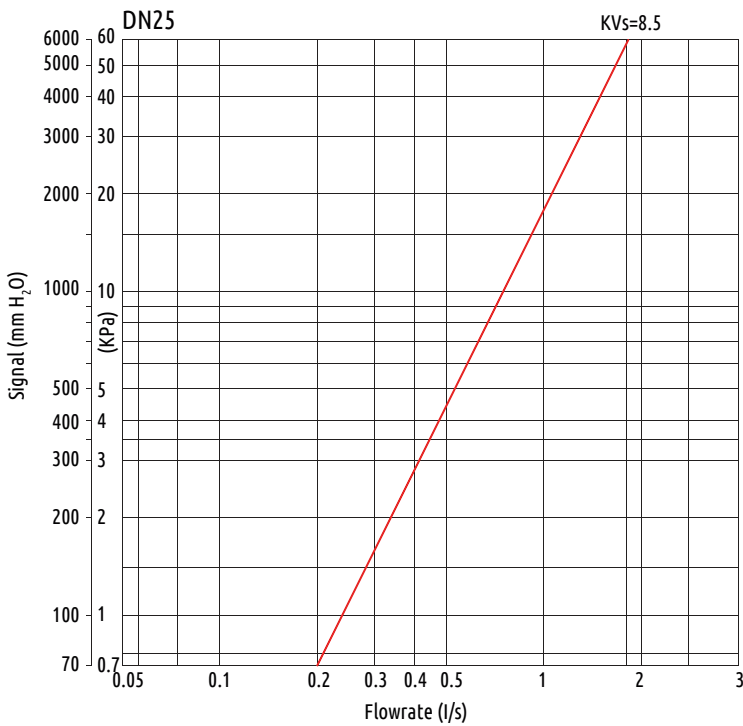
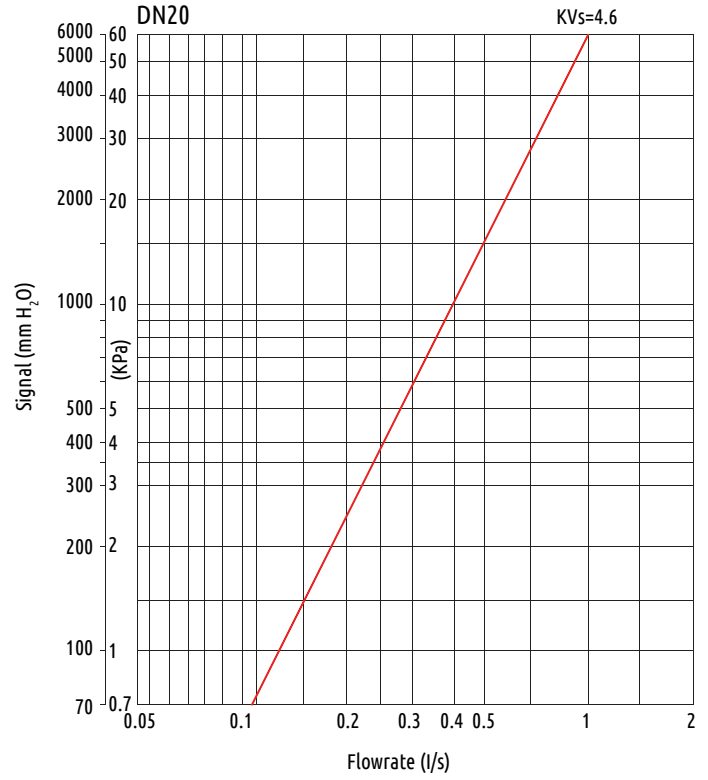
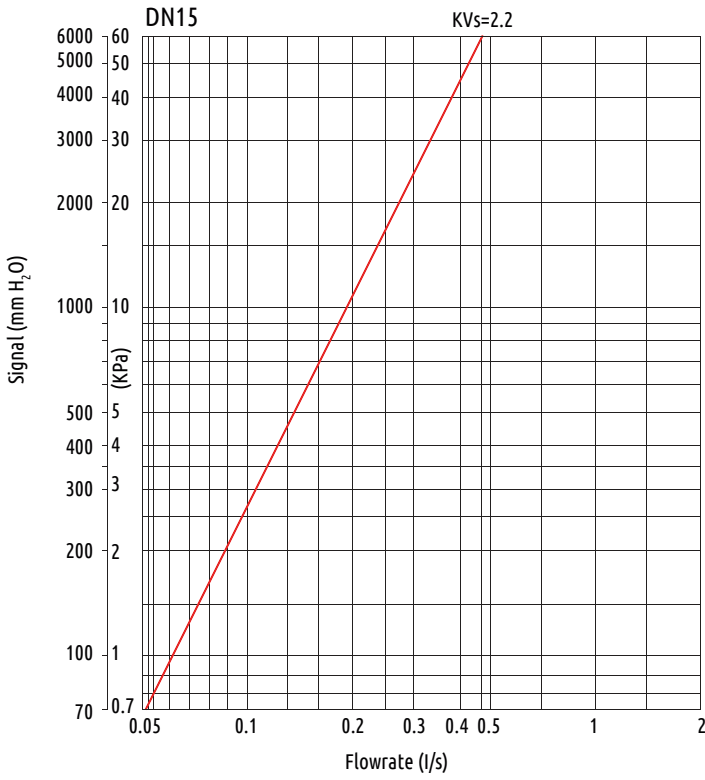

BRONZE FIXED ORIFICE DOUBLE REGULATING VALVE

PN25 F6G25

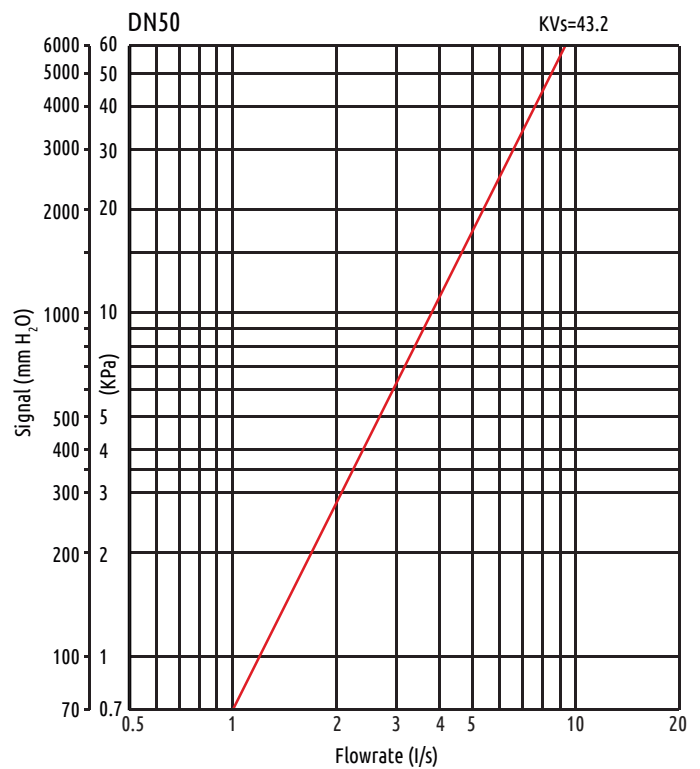
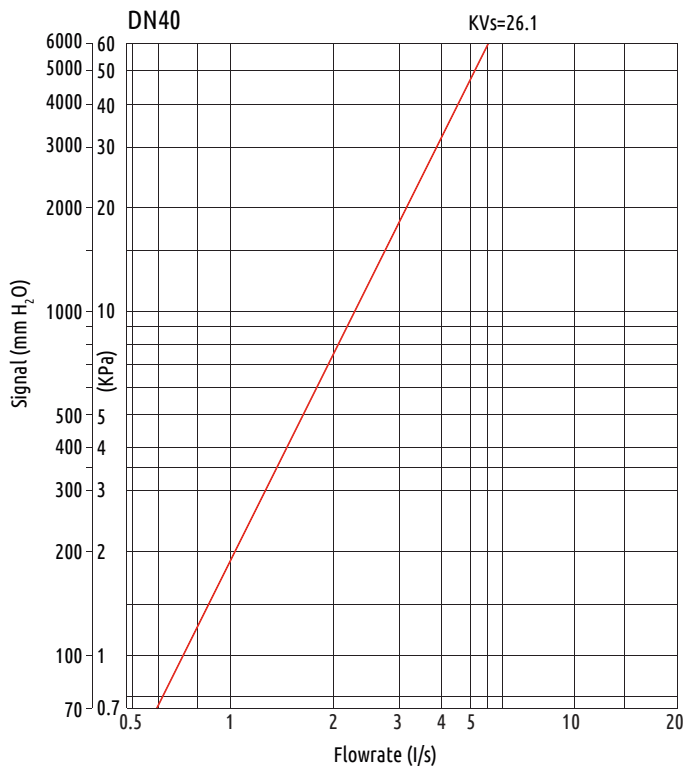

INSTALLATION & OPERATION GUIDE

Install the Double Regulating Valve in the pipe line by ensuring the arrow marking on the valve is same direction as piping flow.

To achieve flow measurement accuracy, it is essential that the piping on the inlet and outlet of the valve is straight and has a minimum length equivalent to 5 times Diameter inlet and 2 times Diameters outlet as shown. If the valve is install at the discharge of a pump set, it is essential that the straight pipe length between pump outlet and valve has a minimum length of 10 times Diameters.

Design flow is achieved by pre-setting valve's opening position, which could be read from scales at the handwheel. Contact your local distributor for information on electronic commissioning meter.

To lock the pre-setting of the valve, remove the cap at the top of the handwheel. Tighten the screw using a hexagon wrench and reassemble the cap.

